

# CEDRAL



The world of Facades

## Give your house a timeless facade

- ✓ *factory applied colour*
- ✓ *low maintenance*
- ✓ *easy to install*

[www.cedral.world](http://www.cedral.world)



# The DNA of Cedral

## The natural origins of Cedral

Cedral sidings is a high-quality and durable composite material, produced using natural raw materials: cement, water and wood fibres.

These fibre cement planks create a beautiful contemporary look that will last a lifetime.

## Ideal for new-build and renovation projects

A sustainable and contemporary material, Cedral is ideal for renovations and new builds across both the whole or part of your house, creating a stunning, individual look to your home

## Hard as a stone, workable as wood

Thanks to the multilayer fibre structure, the fibre cement planks combine the durability of stone with the design flexibility of wood.

The planks are available in a range of colours with a timber effect finish and a modern textured look.



CEMENT

SAND

CHALK

FIBRES

Cedral Wood Lap  
C 01 Everest - White







# Choose Cedral sidings for your facade

The timeless look of Cedral gives design style to every home and is ideal for use alongside other building materials such as brick and render.

## 1. Choose from a range of colours

Cedral planks are available in a wide range of colours and can be placed both vertically and horizontally.

Let your creativity run free and give your house a personal colourful touch.

## 2. A durable facade

A Cedral facade helps to protect your home against the harshest weather conditions.

Cedral has excellent water, UV and frost resistant properties.

The fibre cement planks are also resistant to rot and immune to attack by fungi, bacteria, insects and vermin, ensuring your facade will stand the test of time.



Michael Durgaram

Cedral Wood Lap

C 14 Atlas Brown - C 03 Clay - C 15 Dark Grey - C 05 Grey - C 55 Taupe

### 3. Achieves a top fire rating

Did you know that our building materials have an excellent reaction to fire rating. Officially the classification is A2-s1,d0. Being part of the A group means our materials have no restriction on where they can be used, and in some countries can be considered as non-combustible. The s1 rating is the highest level of performance against generating smoke, while the d0 rating means that the material does not produce flaming droplets. In short they are non-flammable.

### 4. Perfect for renovation

Fibre cement cladding is the ideal material for the renovation of a facade. They cover imperfections and protect newly installed insulation, resulting in professionally finished aesthetic. The cladding is installed to the outside of your home ensuring minimal disruption during your renovation project.





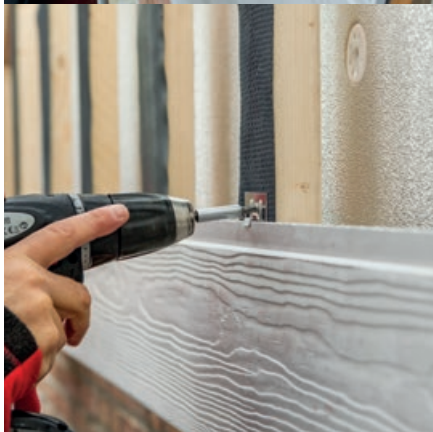

## 5. Low maintenance

During production, the Cedral planks are coated with layers of UV resistant paint. The material is dimensionally stable and rot resistant, so that you no longer have to regularly maintain it in the future. Wash off occasionally with soapy water to help keep your facade looking as good as new.

## 6. Easy to install

The support structure for a Cedral facade is simple: vertical battens with a centre-to-centre distance of up to 60 cm.

The Cedral range also includes a complete range of colour matched trims and touch up paint to complete your facade beautifully.

Bespoke screws and clips ensure quick and easy installation, creating a flawless finish.

Arch. Patrick Kint

Cedral Wood Lap  
C 50 Black

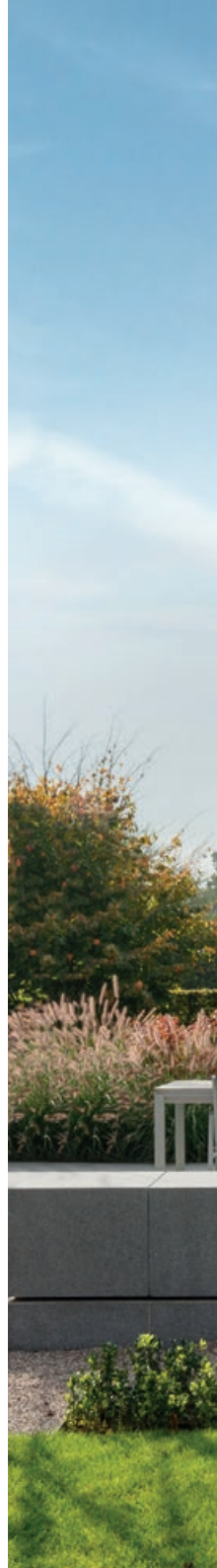





# Choose your finish

**Do you want a timber effect  
or a flat, smooth facade?**

All colours are available in a wood effect  
or a smooth, modern finish.

SMOOTH

WOOD





SMOOTH

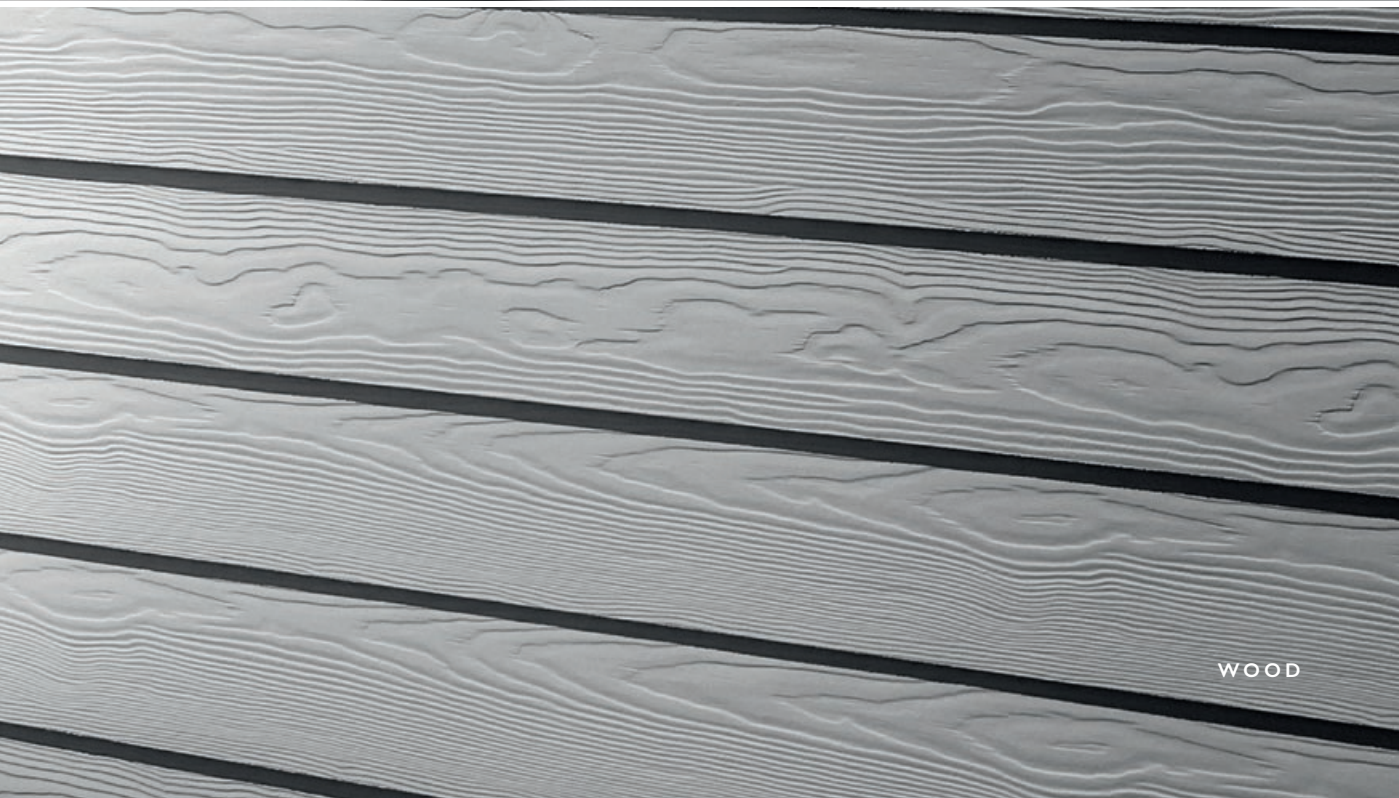

WOOD



CEDRAL LAP



CEDRAL CLICK

# Do you opt for Lap or Click placement?

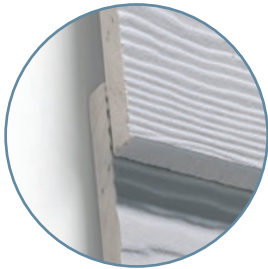

## Cedral Lap

Installed in a traditional shiplap style, giving your facade beautiful, deep shadow lines.

Length 3600 mm  
Width 190 mm  
Thickness 10 mm  
Weight per plank 11,2 kg



## Cedral Click

The Cedral Click sidings are a flush fitting, tongue and groove cladding board, providing a contemporary look to your house.

Length 3600 mm  
Width 186 mm  
Thickness 12 mm  
Weight per plank 12,2 kg



# Do you like the horizontal or vertical design?

You can install Cedral sidings in a number of ways. You can install Cedral Lap and Cedral Click horizontally and vertically, in a number of design options.

**Horizontal Click**





Drieskens en Dubois  
Cedral Wood Click  
C 03 Clay

**Vertical Click**

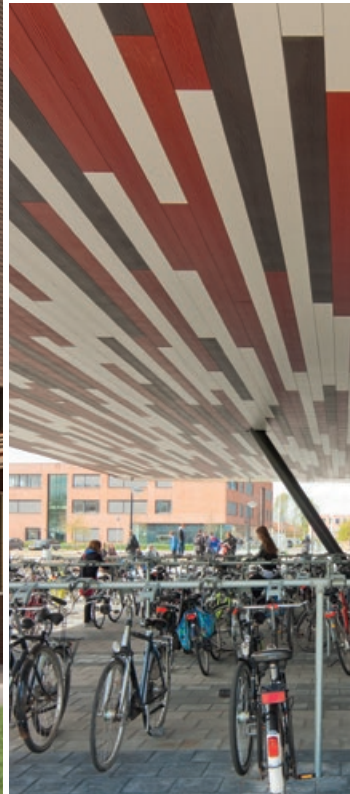





# One colour or with accents?

With sidings you have the freedom to create stand out projects.



Cedral Smooth Click  
C 05 Shark Grey



Van den Berg Kruisheer Elffers Architecten

Cedral Wood Lap + Click  
C 01 Everest-White - C 04 Dark Brown - C 61 Swedish Red

# Choose the colour for your project

## Mineral Colors

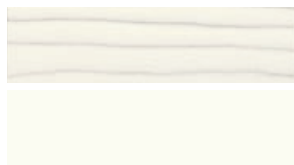

C 01 Everest White  
RAL: 9003 - NCS: S 0500 - N



C 05 Shark Grey  
RAL: 7047 - NCS: S 3000 - N



C 52 Pearl  
RAL: 7030 - NCS: S 4502 - Y



C 56 Metal Grey  
RAL: / - NCS: S 5502 - Y



C 53 Lead  
RAL: 7039 - NCS: S 6502 - Y



C 54 Mouse  
RAL: 7037 - NCS: S 6500 N

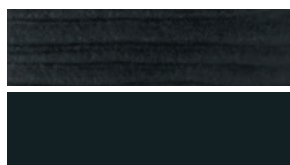

C 50 Black  
RAL: 9011 - NCS: S 9000 N

## Forest colors

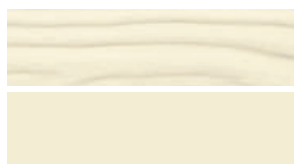

C 07 Cream White  
RAL: 9001 - NCS: S 1005 - Y 10 R



C 02 Vanilla  
RAL: 1015 - NCS: S 1010 - Y 20 R



C 57 Vintage Beige  
RAL: / - NCS: S 4010 - G 90 Y



C 58 Olive Green  
RAL: 7002 - NCS: /



C 59 Quartz Grey  
RAL: / - NCS: S 6005 - G 80 Y

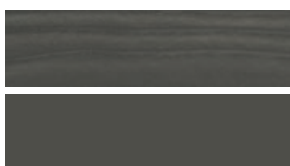

C 60 Anthracite  
RAL: / - NCS: S 7502 - Y



C 04 Dark Brown  
RAL: 8019 - NCS: S 8005 - Y 80 R

## Earth Colors

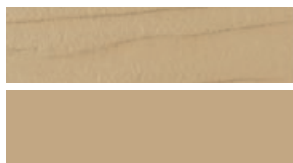

C 11 Cappuccino  
RAL: 1001 - NCS: S 3020 - Y 20 R



C 03 Clay  
RAL: 1019 - NCS: S 3005 - Y 20 R



C 14 Atlas Brown  
RAL: / - NCS: S 4005 - Y 50 R



C 55 Mol  
RAL: 7006 - NCS: S 6005 - Y 50 R



C 61 Swedish Red  
RAL: / - NCS: S 5040 - Y 80 R

## Ocean Colors



C 15 Ash Grey  
RAL: / - NCS: S 6005 - R 80 B

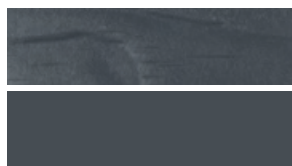

C 18 Slate Grey  
RAL: 7024 - NCS: S 7502 - B



C 31 English Green  
RAL: 6009 - NCS: S 8010 - G 10 Y



Please note: the colour photographs above, as well as the RAL and NCS codes, are for reference only and we recommend you request a sample.

# These Cedral Sidings projects prove its success

## Complete house



Atelier d'Architecture Gauthoye-Berhaut S.A.  
Cedral Smooth Lap  
C 03 Clay

Cedral Smooth Lap  
C 50 Black

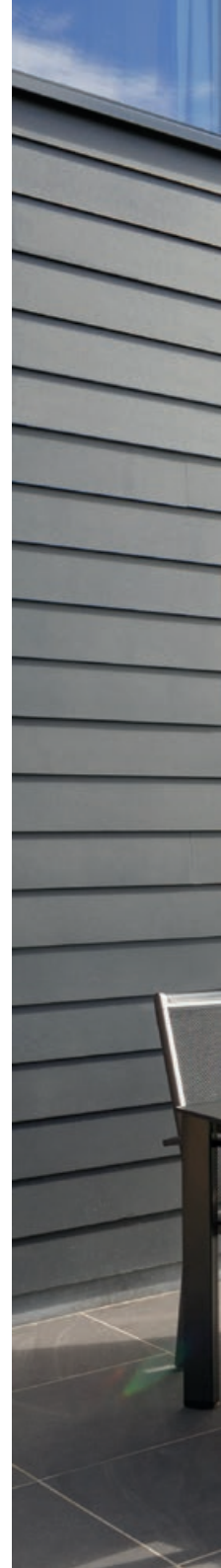





Complete house



scprl Arch. Urb. Valentiny & Associés  
Cedral Wood Lap  
C 02 Vanille







## Facade party

Combination with render

Cedral Wood Click  
C 03 Clay - C 18 Slate Grey

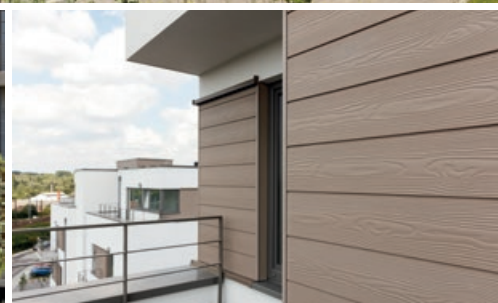

Drieskens and Dubois  
Cedral Smooth Click  
C 03 Clay

**Facade party**  
Combination with render



Architectural firm S.H.M. van der Linde BV

Cedral Wood Click  
C 04 Dark Brown









## Facade party

Combination with brick and with render

Heiderich Architekten

Cedral Smooth Lap  
C 50 Black



 Drieskens and Dubois  
Cedral Wood Click  
C 03 Clay

**Facade party**  
Integrated solutions

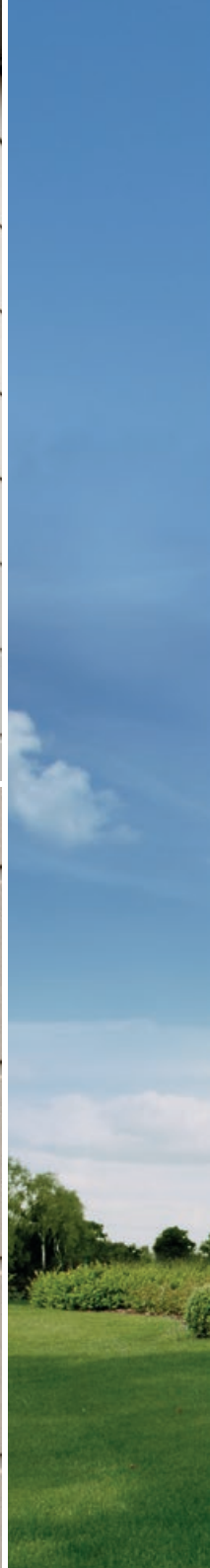





Top gable roof





Arch. Luc Willem  
Cedral Wood Click  
C 03 Clay - C 01 Everest White - C 05 Shark Grey





Top gable roof



 Architect Angeline Nys  
Cedral Wood Click  
C 07 Cream White





## Facade party and carport

CedralWood Lap  
C 61 Swedish Red - C 05 Shark Grey



Arch. Jan Giezen  
CedralWood Lap  
C 15 Ash Grey





## Extension of a home



Cedral Smooth Click  
C 05 Shark Grey

# Complete Installation Solution

## Aluminium profiles

We offer a complete range of colour matched aluminium profiles for Cedral Lap and Cedral Click.

PROFILES (dimensions in mm)	CEDRAL LAP	CEDRAL CLICK
<p><b>1</b> External corner (symmetrical)</p> <p>This profile can be used as finishing external corners.</p>		
<p><b>2</b> External corner (asymmetrical)</p> <p>Can be used as an external corner profile or as detailing on a window reveal.</p>		<p>Niet van toepassing</p>
<p><b>3</b> Internal corner</p> <p>To finish the corner where Cedral meets on an internal corner, forming a seal between the trim and the corner.</p>		
<p><b>External Corner Junction</b></p> <p>Used as a corner joining piece. Only available in black. Length 300 mm.</p>		
<p><b>4</b> Start profile horizontal installation</p> <p>Used to start a horizontal cladding run of the façade planks.</p>		
<p><b>Start profile vertical installation</b></p> <p>Used to start a vertical cladding run.</p>	<p>Does not apply</p>	



**PROFILES** (dimensions in mm)

**CEDRAL LAP**

**CEDRAL CLICK**

**5 Perforated closure**

Shields the air cavity against pest infestation and debris.  
Finish in aluminium or black lacquered aluminium.  
Length 2.5 m.

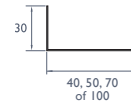
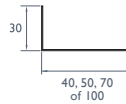

**6 Connection profile**

End trim to finish Cedral when used as a single piece  
on a window reveal or soffit.

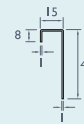
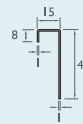

**7 Lintel profile for window**

Used to finish the cladding above the window and to  
support the next course of Cedral Click.

Does not apply



**8 End profile**

Hides any sharp corners and protects the Cedral edges  
from wear and tear.

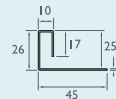

Does not apply

## Accessories

(dimensions in mm)

CEDRAL LAP

CEDRAL CLICK

### 9 Cedral Click Clip and screws

Does not apply

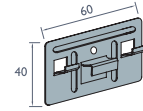

### 10 PE joint tape

### 11 EPDM joint tape

Colour matched, mushroom head Cedral screws and retouch paint are also available. For more information, download the Cedral Installation Guide at [www.cedral.world](http://www.cedral.world)

## Profiles and accessories Cedral Board

(dimensions in mm)

### 1 External corner Cedral Click

Can be used as an external corner profile when finishing around a window or when using as a soffit or fascia.

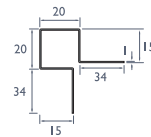

### 2 External corner (asymmetrical)

Can be used as an outer corner profile when finishing a window with Cedral Board in combination with Cedral Lap.

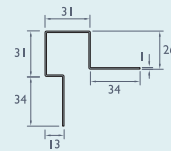

### Ventilation profile

Provides ventilation behind Cedral Board and the sealing of the joints at eaves and buoy edges.



### 6 Connection profile

End trim to finish Cedral when used as a single piece on a window reveal or soffit.

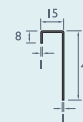

### Cedral Click

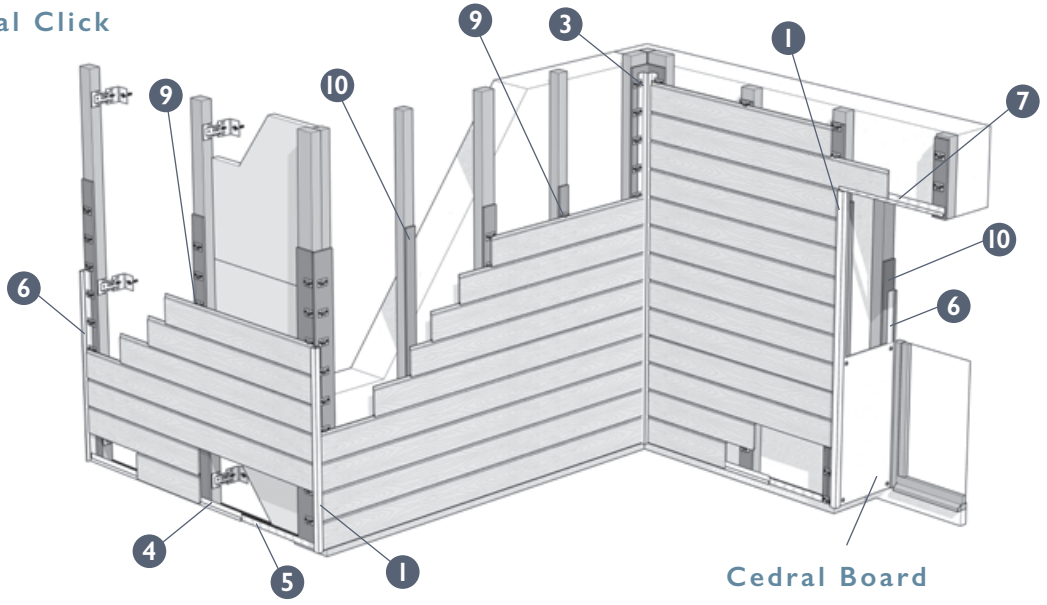

### Cedral Lap

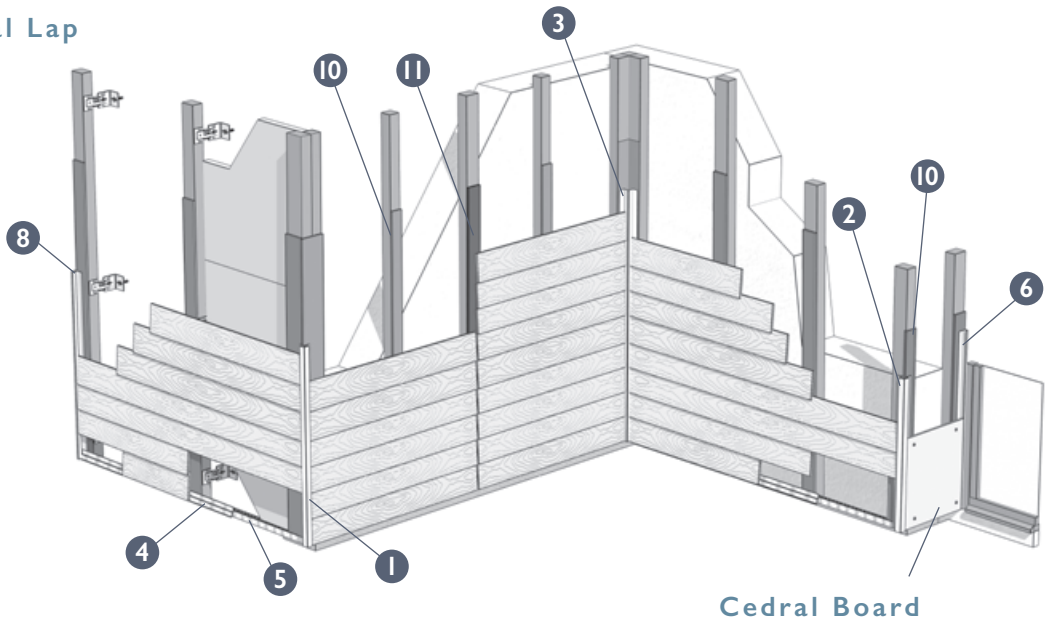

# The importance of ventilation

**To ensure the best results and longevity of your facade, you must always have good ventilation**

Use a perforated closure at the bottom and top of the facade as well as above and below windows to limit the obstruction of the necessary 35mm ventilation gap behind the sidings.

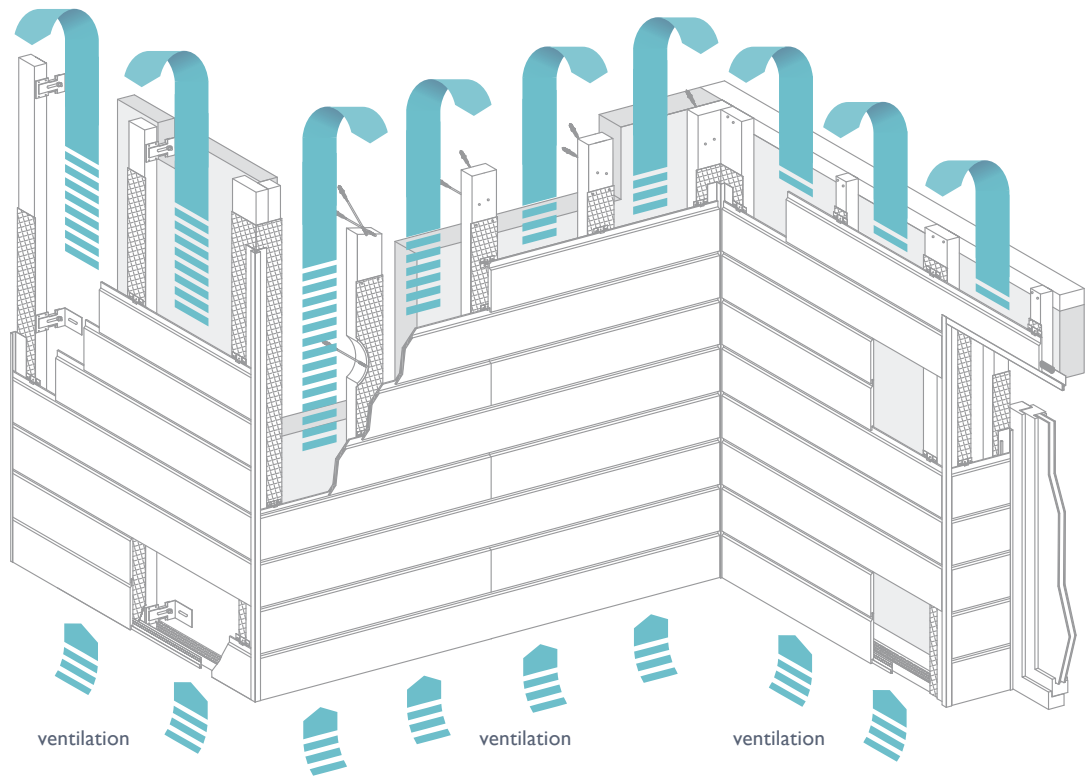

### CEDRAL LAP AIR CIRCULATION

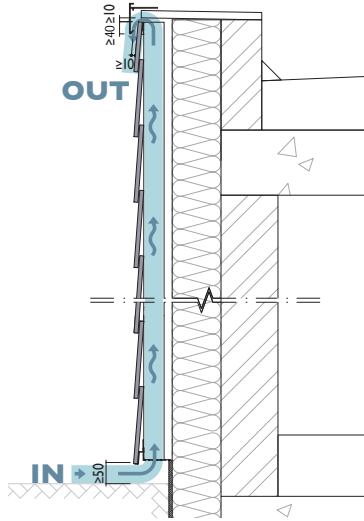

### CEDRAL CLICK AIR CIRCULATION

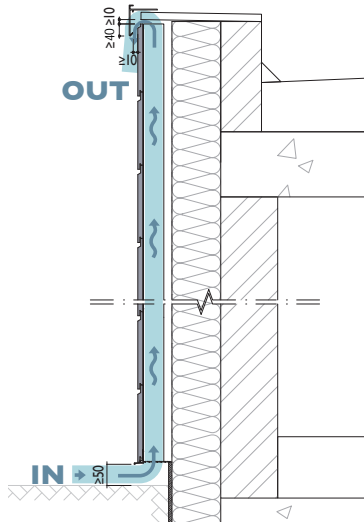

Exterior ceiling in Cedral Board

# Cedral Board

## The perfect finish

To perfectly finish your entire home, Cedral also offers Cedral Board for use on the soffit and fascias

Cedral board is available in the same colours as the sidings.



Cedral Board as drain



Roof finish in Cedral Board



# CEDRAL



The world of Facades



Do you require a free  
colour swatch?

Are you looking for a  
Cedral facade installer?

Do you need a quotation  
from a dealer or  
professional in your area?

To make these requests  
and to find out more, visit  
[www.cedral.world](http://www.cedral.world)



[www.cedral.world](http://www.cedral.world)

Etex Exteriors ANZ  
Suite 201, 198 Harbour Esplanade, Docklands VIC 3008, Australia  
+61 (03) 9988 2290  
[info.anz@cedral.world](mailto:info.anz@cedral.world)

an **etex** company