

CEIDRAL®



The World of Roofs

Fibre cement slates

FIXING GUIDE

Cedral fibre cement slates fixing guide

Cedral are the market leader in the design and manufacture of roofing products in Ireland. With over 80 year's experience, we have developed a deep understanding of the roofing requirements for the Irish market and our slates are specifically designed for Ireland's volatile weather.

We offer a wide range of fibre cement slates in a variety of colours, textures and sizes allowing total freedom of design. Cedral's commitment to continual innovation, research and ever-improving standards has enabled us to develop Rivendale and Thrutone Endurance - Ireland's strongest slates.

Cedral slates are manufactured from Portland cement (supplied by Irish Cement), water, synthetic and natural fibres. They are complemented by a wide range of ridges, hips and valleys, together with fixings and accessories for all roofing applications.

Cedral also offer dedicated training for roofing contractors at our Cedral Roofing Academy. This is Ireland's only training facility for roofing and slating.

Contents

4	Fibre cement slate range	21	Eaves ventilation 10mm & 25mm
5	Slate dimensions, lap, gauge and estimating	26	Standard eaves
7	Lap treatments	30	Slate verge trim
8	Underlay and battens	32	Ventilated ridge and hip roll
10	Materials and storage	34	Close mitred hips
12	Site working	36	Open metal valley
13	Setting out	38	Abutments
14	Nail and rivet fixing	40	In-line slate vents
		46	Cedral Roofing Academy



This guide shows a range of standard detailing, dry fix and ventilation solutions. Fibre cement slates are equally complemented by fibre cement and clay fittings. For more information, please contact our Technical Support Department.

This fixing guide contains detailed advice on best practice to comply with the requirements of the Building Regulations, SR82, BS5534 and BS8000: Part 6, and is intended for general applications where Cedral slates are used. Where non-standard situations occur, users must satisfy themselves as to the suitability of the recommendations given.

The Cedral slate range

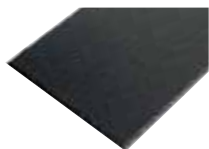

Rivendale

A finely detailed surface and dressed edges that together reproduce the attractive appearance of natural slate.

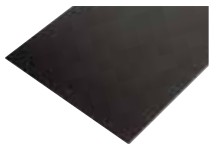

Thrutone Endurance Smooth

A superb smooth finish and square edges, which will result in a classic, elegant roof. Ireland's strongest and best selling slate.

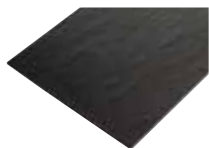

Thrutone Endurance Textured

An attractive textured surface with square edges. Part of the Endurance range, which is the strongest in Ireland.

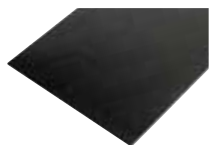

Supercem

A smooth surface with square edges, Supercem slates are deep black in colour. Available in rectangular shape in 600 x 300mm.

Slate dimensions, lap, gauge and estimating

Cedral slates are suitable for roof pitches of 25° and above and for vertical cladding.

Table 1: Slate dimensions

Size of slate (mm)	Typical laps (mm)	Gauge of battens (mm)	Battens per m ²	No. of slates (per m ²)	Weight of slates as laid (kg/m ²)
600 x 300	110	245	4.08	13.6	20.9
600 x 300	100	250	4.00	13.4	20.4
500 x 250*	100	200	5.00	19.6	21.3

* 500 x 250mm slates to have minimum pitch of 30°

Estimating

Basic information regarding the stated sizes and laps for estimating purposes is given in Table 1, above. These are approximate values.

To calculate the number of doubles required for verges, divide the rafter length by the batten gauge. Round up to a whole number and divide by 2 as they are on alternate courses. Multiply by the number of verges.

For example, for a rafter length of 10m, a batten gauge of 250mm and 4 verges, the following calculation would apply:

$$10 \div 0.25 = 40 \div 2 = 20 \times 4 \text{ verges} = 80 \text{ doubles}$$

Lap treatments

The appropriate lap will depend on the pitch of the roof, together with other factors such as the exposure of the site, the length of the rafters and other design considerations.

Where abnormal conditions may be expected, e.g. on elevated sites, near the coast or in localities where heavy falls of snow are common, the lap treatments will vary. Refer also to SR82 and BS5534.

Table 2a: Minimum Pitches and Laps

Cedral Fibre Cement Slates: Normal exposure

Size of slate (mm)	25° -30° (mm)	30° -35° (mm)	>35° (mm)
600 x 300	110	100	90
500 x 250	N/A	100	90
400 x 400	N/A	N/A	100

Table 2b: Minimum Pitch and Laps

Cedral Fibre Cement Slates: Severe exposure

Size of slate (mm)	25° -30° (mm)	30° -35° (mm)	>35° (mm)
600 x 300	110*	110	100
500 x 250	N/A	100*	100
400 x 400	N/A	N/A	100

*The use of a high-performance roofing underlay is recommended.

Table 3: Windloading

Size of slate (mm)	Maximum wind suction loading**
600 x 300	2000 N/m ²
500 x 250	2500 N/m ²

** When using two 30mm x 2.65mm long copper nails with copper disc rivet (19mm x 2mm stem, 19mm dia x 0.5mm thick base) in accordance with SR82 and BS5534.

Underlays

Underlays draped over rafters (i.e. not fully supported) should meet the requirements of SR82 and BS5534 with appropriate third party accreditation e.g. IAB or BBA certificate.

The side laps of the underlay should be a minimum of 100mm.

The head laps of the underlay should be as per Table 4 below. Each end of the underlay should be securely fixed over the rafters.

Table 4: Head laps of underlay

Pitch	Minimum head lap not fully supported	Minimum head lap fully supported
25° up to 34°	150mm	100mm
35° and above	100mm	75mm

Using slates with a vapour permeable (LR) underlay

When specifying a close fitting covering which is relatively airtight (such as fibre cement slates), there is a risk of interstitial condensation forming on the underside of the underlay and the external covering.

To avoid risk, the batten space should be ventilated in accordance with BS5250:2011 using a ventilated counterbatten void.

Battens

Battens should comply with SR82 or BS5534 and be of softwood timber not less than 1200mm in length. They should be free of any sign of decay, insect attack, splits, shakes, knots or knot holes greater in size than one third of the width of the batten. The ends of each batten should always be fully supported.

Table 5a: Batten size: ROI

Rafter spacing (mm)	Nominal Size (mm)	Minimum batten size (mm)
Up to 400	50 x 22	47 x 22
401 - 600	50 x 36	47 x 35

Table 5b: Batten size: NI

Rafter spacing (mm)	Minimum batten size (mm)
Up to 450	38 x 25
451 - 600	50 x 25

Materials

Nails and rivets

Slate nails: nails for fixing should be 2.65mm (12 swg) Cedral jagged copper nails, 30mm long.

Batten nails: nails for fixing battens should be in accordance with SR82 and BS5534.

Slate rivets: copper disc rivet, 19mm x 2mm stem, 19mm dia. x 0.5mm thick base.

Lead

When lead is used for flashings and soakers, lead oxide carried in the water run-off is likely to stain the slates. To avoid this, apply 'Patination Oil' to the lead immediately before it is fixed.

Information on the supply of patination oil can be obtained from Cedral Technical Support Department, Telephone +353 (0) 59 863 1316. For details of all leadwork, flashings and 'Patination Oil' please consult the Lead Sheet Association, Telephone +44 (0) 1622 872432.

Storage

Storage of slates

Slates should not be allowed to become wet when in packs or banded together, as efflorescence and staining can occur:

Storage inside a building or similar shelter: the polythene hoods covering the slates should remain as a temporary protection to the slates, provided no water vapour can enter from below the packs.

Storage outside: remove the polythene hoods and stack the slates in bundles off the ground and cover with a good tarpaulin allowing clearance between the tarpaulin and the slates. This will allow free air movement and help prevent condensation forming within the pack (which could cause efflorescence).

On larger contracts, it is better to avoid storing too many packs on-site and to schedule deliveries of slates as they are required.

Slates should be fixed in accordance with SR82 'Irish Code of Practice for Slating and Tiling' and BS5534 'British Code of Practice for Slating and Tiling' and BS8000-6 'Workmanship on building sites. Code of practice for slating and tiling of roofs and walls'.

Siteworking

Slates should be scored using a scribing tool and snapped over a straight edge.

Slates can be cut using a normal handsaw/hacksaw with teeth of 3mm - 3.5mm pitch, preferably wide set. Saws should always be used to start off when cutting acute angles.

Additional fixing holes should be drilled using a 4.0mm dia. standard drill bit.

Fixing holes must not be punched.

After cutting or drilling, remove cutting dust from the slate to avoid subsequent staining.

Cedral fibre cement slates should not be cut with a slater's axe.

Note: In all cases, dust or swarf should be removed immediately from the slate edge, to reduce the possibility of cement staining when the slate is first wetted by rainfall.

As this product is made of mainly mineral raw materials, it can contain traces of quartz. Mechanical machining (cutting, sanding, drilling) of this product can release dust which may contain quartz particles.

Always apply the appropriate general and personal protective measures when mechanically machining these products:

- 1 Avoid generating airborne dust by using tools with dust extraction and/or suppression.
- 2 Guarantee adequate ventilation in the workplace.
- 3 Wear the appropriate personal and respiratory protection to avoid inhalation of dust and contact with eyes and skin.

For further information, please contact the Cedral Technical Support Department on +353 (0) 59 863 1316.

Setting out

Setting out of battens

Roofs should be set out with battens to the appropriate gauge. Select the appropriate gauge for the slate size by using the following formula:

$$\text{gauge} = \frac{\text{length of slate} - \text{lap required}}{2}$$

Allow the eaves slates to overhang into the gutter by approximately 50mm. The verge overhang should be restricted to a maximum of 50mm. Care must be taken when setting out to avoid the need for rectangular cut slates less than half the width of the slate to be used, as it may be difficult to fix. Wherever possible, use full slates or slate-and-a-half slates.

A vertical or raking batten is advisable at the verge and at intersections.

Nail and rivet fixing

Introduction

- All slates should be fixed in accordance with SR82, BS5534 and BS8000-6.
- Slates should be laid broken bond using slate-and-a-half width slates in alternate courses formed from double width slates at verges, hips, valleys and abutments.
- Maximum 5mm gap between adjacent slates for disc rivet shank, 3-4mm is optimum.
- Nail slates firmly but do not drive nails too tight to the surface of the slate.
- For full details of headlap please refer to table 4 on page 6.

Fixing method

Ensure each slate is centre nailed with 2 No. 30mm x 2.65mm jagged copper nails and restrained at the bottom edge with a copper disc rivet (19mm x 2mm pin, 19mm dia. x 0.5mm thick base) with the pin bent through 90°. Double or slate-and-a-half slates must be fixed with 3 No. nails and 2 No. rivets (see fixing positions Fig.7, page 19).

Technical Support

If you have any questions or difficulties with the installation of Cedral fibre cement slates, please contact the Cedral Technical Support Department on +353 (0) 59 863 1316.

Nail and rivet fixing

Installation procedure for laying and fixing slates

- 1 Set out the roof battens by calculating the gauge using the formula on page 10. Allow for the eaves courses of slates to overhang the fascia or tilting fillet so that the tails align with the centre of the gutter (approx. 50mm).

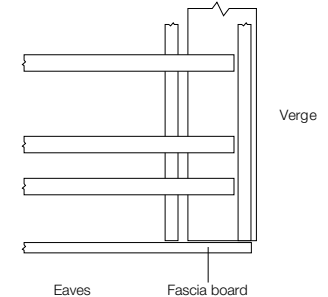

- 2 Set out both under-eaves battens to accommodate the two lengths of under-eaves slates (Table 6, page 21) allowing for correct lap and gauge. Cut the under-eaves slates from a standard slate and drill 2 no. 4mm dia. holes approximately 10-15mm in from the top cut edge and head nail the first under-eaves course along the eaves.

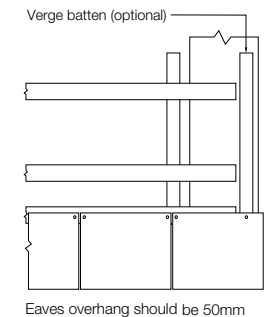

Nail and rivet fixing

- 3 Cut and nail fix second under-eaves course to the lower eaves batten with slate-and-a-half widths at the verge, ensuring a copper disc rivet is fitted centrally between adjacent slates (5mm gap) to align the pin with the hole in the front edge of the first course of full length slates. Prior to fixing the slate-and-a-half verge slate, drill a 4mm dia. hole half a slate width distance in from the verge and 25mm up, to allow for the disc rivet to fix the first full slate course above.

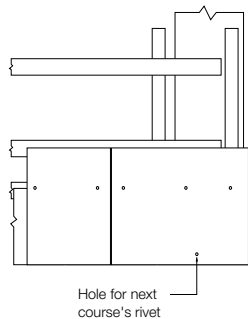

- 4 At the verge, a second hole (4mm dia.) is required to allow for the copper disc rivet for the next course. This is drilled 50mm from the outside edge of the slate and 25mm plus gauge distance from the bottom edge or tail.

Continue to lay the first course of full length slates, twice nailing each slate, and inserting a copper disc rivet between adjacent slates aligned with the hole in the front edge of the slate above.

When the next course of slates is laid above, the rivet shank is passed through the hole in the front edge of the slate and the rivet pin bent 90° so that it faces down the roof slope to secure the tail of the slate.

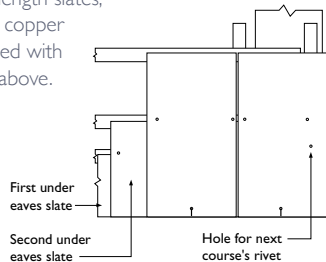

Nail and rivet fixing

- 5 To achieve the correct bend in the rivet pin, it is best to tap it twice with a hammer; once at about 45° to the pin, and then finally onto the surface of the slate.

At the verge, a second hole (4mm dia.) should be drilled 50mm distance from the outside edge of the slate, and 25mm plus the gauge distance from the tail, to allow the disc rivet pin to be inserted for the next course above.

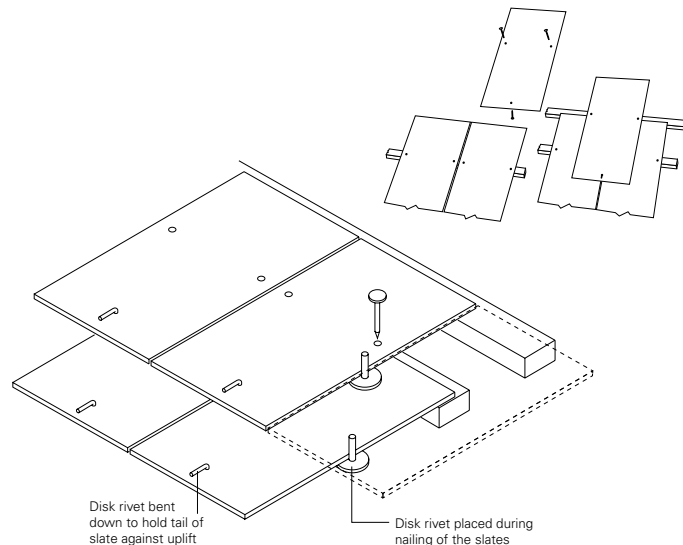

Nail and rivet fixing

- 6 At verges and abutments, lay the first full length slate-and-a-half slate, ensuring that 3 no. 4mm dia. holes are drilled on the batten line with 2 no. additional holes for the copper disc rivets.

For remaining courses where single and slate-and-a-half slates are used, a third disc rivet hole is needed to allow for the rivet pin for the next single width verge slate (at point C). This is drilled half the single slate width from the side of the slate and 25mm plus the gauge distance from the tail.

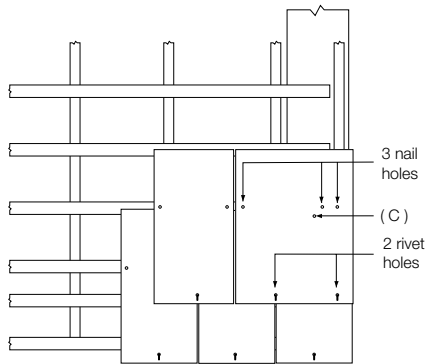

Nail and rivet fixing

- 7 Continue diagonally up the roof with standard size slates, trimming to verges, hips, valleys and ridges as required.

Slate-and-a-half widths should be used if the half slate is less than 150mm wide.

At valleys and hips where slates need to be cut on the rake, wide slates must be used to maintain an adequate width and sidelap at the head or tail.

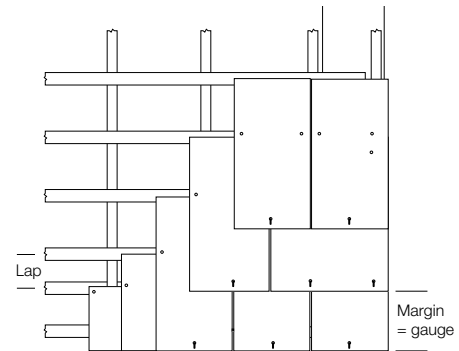

Nail and rivet fixing

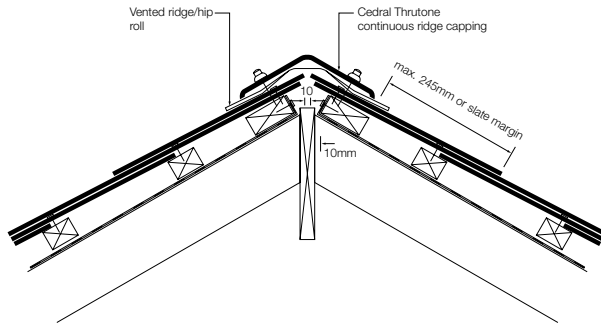

- 8 At the roof apex or top abutment, an additional top course batten is fitted directly above the last full length slate batten. The last full length roof slates/ short courses are cut to length so that their top edges rest on the lower batten and are centre nailed as normal.

The top course slates should be cut to length and head nailed as per the under-eaves course slates with a disc rivet fitted to the tail.

Note: To ensure the top course slates lay neatly, a thicker batten can be used to compensate for the thickness of the slate course below.

Eaves ventilation 10mm and 25mm

Ventilation requirements to be in accordance with SR82, BS5534 and the Building Regulations Technical Guidance Document F - Ventilation. When using an over fascia vent, an underlay support tray is required.

This provides support to the underlay while also allowing unobstructed ventilation into the roof space. It also removes the need for 5u felt at the eaves.

Cedral eaves ventilation systems are designed to provide continuous 10mm or 25mm free vent areas to roof voids in an efficient and unobtrusive manner.

The 25mm vent can also be used to ventilate the batten cavity where this is required on a counter batted roof.

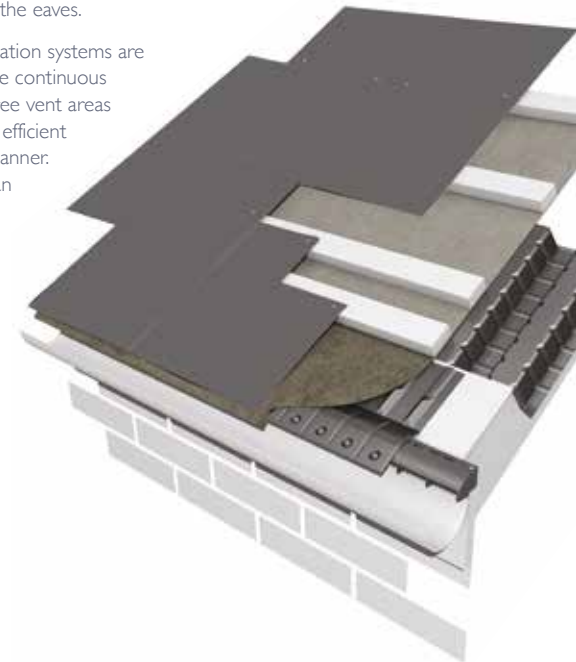

Eaves ventilation 10mm and 25mm

25mm over fascia eaves vent system

Warm roof construction*

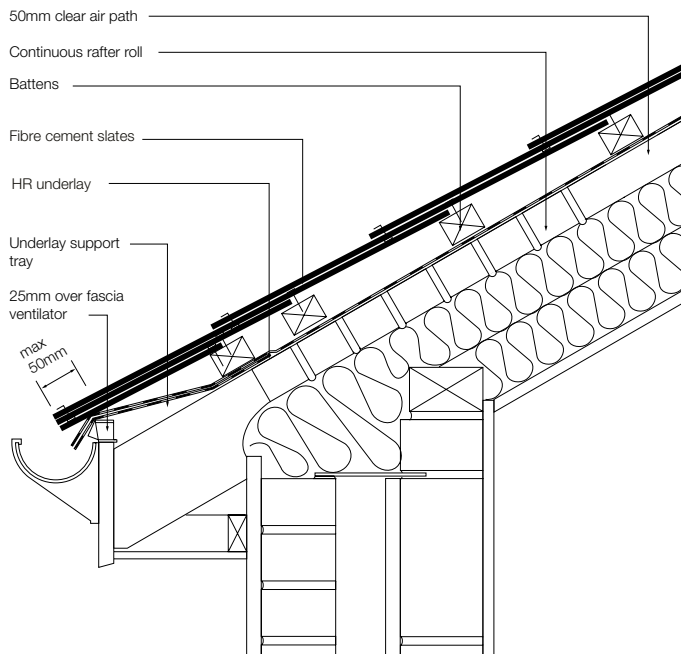

* If an LR underlay is used, then 25mm counterbattens are required.

Eaves ventilation 10mm and 25mm

10mm over fascia eaves vent system

Cold roof construction*

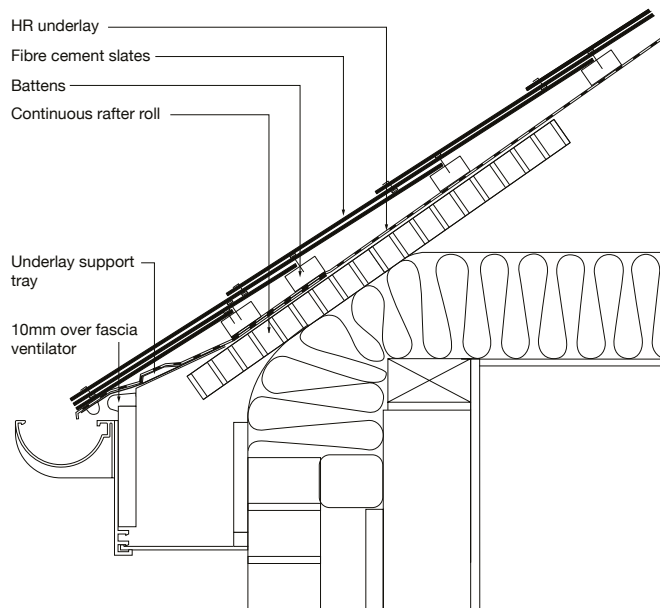

* If an LR underlay is used, then 25mm counterbattens are required.

Eaves ventilation 10mm and 25mm

Rafter roll

The continuous rafter roll provides a clear airpath over the insulation irrespective of soffit width and roof pitch by preventing the insulation blocking the eaves ventilator.

It will accommodate rafter centres from 400mm to 600mm whilst still providing the correct nett free area.

Fixing method

- 1 Locate and nail one end of the rafter roll over the rafter.
- 2 The formation will fit directly onto the rafters at 400mm and 600mm centres.
- 3 By pulling to extend the length of the panel it may also be attached to rafters at differing centres.
- 4 Subsequent panels should overlap on the rafter fixing.
- 5 Fix the eaves ventilator onto the fascia with 30mm x 4.0mm galvanised woodscrews.
- 6 Fix the underlay support tray to the rafters. Lay the underlay over the underlay support tray which is dressed into the gutter.
- 7 Fix the eaves batten so as to allow the underlay to oversail the underlay support tray unit and not trap water behind the unit.



Standard eaves

For fibre cement slates, it is essential for the function and long term performance of the roof that three courses of slates are laid at all eaves.

Set out the under-eaves battens to accommodate the typical under-eaves slate lengths as shown in Table 6, page 28.

Eaves batten

Size as slating batten.

Tilting fillet

The dual purpose of the tilting fillet is to ensure that the underlay is evenly dressed over the fascia to avoid trapping water and in association with the fascia, commence the correct laying of the slates. To achieve these functions, the fascia/tilting fillet should be approximately 8-15mm above the top of the general batten level.

Fixing

- 1 Install the underlay parallel to the eaves with the horizontal overlap appropriate to the rafter-pitch (see page 6).
- 2 Ensure that the underlay overhangs the fascia sufficiently to drain into the gutter and that dressing the underlay over the tilting fillet prevents any collection of water.
- 3 Locate and secure the battens to the correct centres appropriate to the size of slate.
- 4 Follow the slate fixing procedure described on pages 11 to 16.

Standard eaves

- 5 Place rivets between the slates on the second under-eaves course, head resting on the lower slate course. Pass the rivet shank through the hole provided in the first full length slate at its tail. Secure slate and dress the rivet shank down the slope.
- 6 Proceed laying further full length slates up the roof.

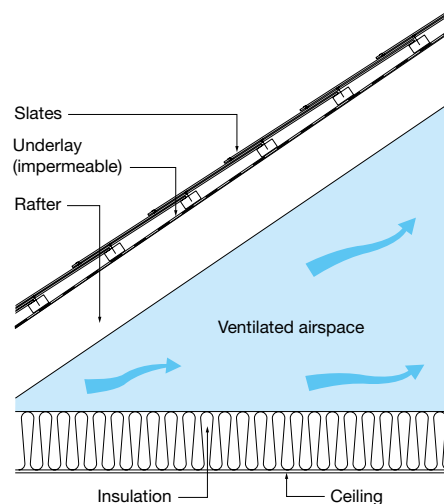

Cold pitched roof with type HR underlay, ventilated void above insulation and a well sealed ceiling

Standard eaves

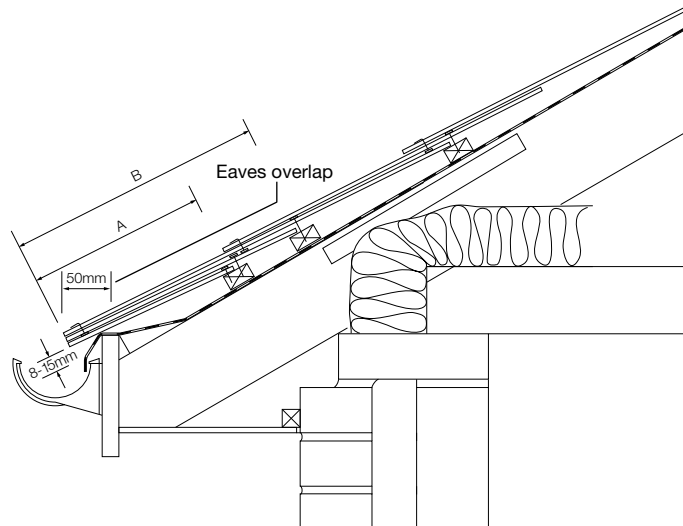

Table 6: Under eaves slate lengths

	Size of slate (mm)	Head lap (mm)	1st under eaves slate length (A) (mm)	2nd under eaves slate length (B) (mm)
25-30°	600 x 300	110	245	355
30-90°	600 x 300	100	250	350
25-90°	500 x 250	100	200	300

Standard eaves

Close-fitting coverings

When specifying a close fitting covering which is relatively airtight (such as fibre cement slates), there is a risk of interstitial condensation forming on the underside of the underlay and the external covering.

To avoid risk, the batten space should be ventilated in accordance with BS5250:2011 using a ventilated counterbatten void.

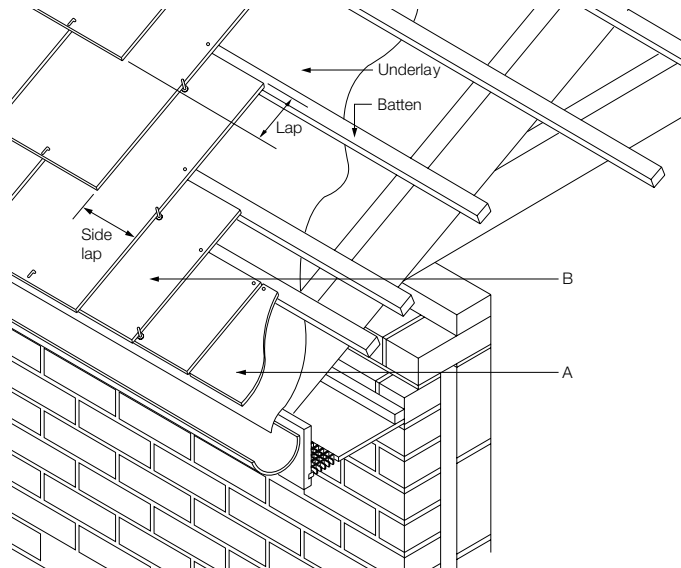

Slate verge trim

ST1 and ST2

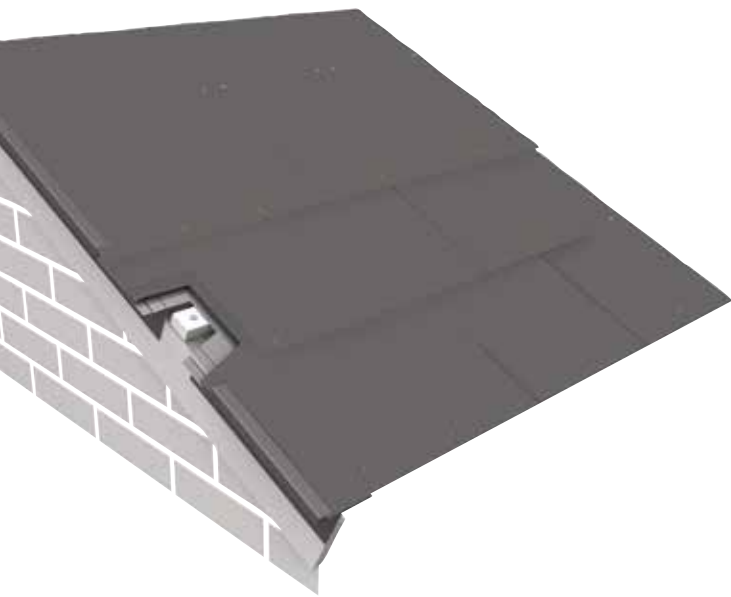

The aluminium slate verge trim provides the benefits of a dry verge for Cedral fibre cement slates. The trim can be used with or without bargeboard but is not suitable for raking verges.

Installation for ST2 verge trim (bargeboards and flush verge)

1 Underlay and battens should be laid and cut flush with outer edge of gable wall or bargeboard.

Slate verge trim

ST1 and ST2

- 2 Position the verge trim on top of the battens and align the vertical leg against the batten ends.
- 3 Position the first length to overhang at the eaves into the gutter, by the required amount, and remove part of the down leg to allow fitting of the gutter.
- 4 Nail the horizontal flange of the trim to each batten using a 25mm long galvanised clout nail ensuring the batten ends are nailed to the substructure.
- 5 When joining adjacent lengths of verge trim, ensure the lower length of trim is nailed securely to each batten (joints at the centre of a batten).
- 6 Cut away a rectangle 15mm in from the end of the trim beneath the drip bead.
- 7 Trim the inside corner of the trim. Make a small triangular cut into the top lap of the trim and press down slightly. This will allow the upper length to push inside the lower length.
- 8 Ensure the two down legs line up. Firmly push into place and nail into position.
If the upper leg is to form part of a ridge joint, carry out the apex cutting process prior to nailing to battens.
- 9 Slide the verge slates under the lip of the verge. Trim and nail in accordance with the recommended fixing specification.

Please note that sheet metal cutters should always be used to cut the trim. Use protective gloves when handling to avoid injury from sharp edges.

A number of trims are available from Cedral. Please refer to www.cedral.ie or contact Cedral's Technical Support Department for further information. Phone: +353 (0) 59 863 1316
Email: info.ireland@cedral.world

Ventilated ridge and hip roll

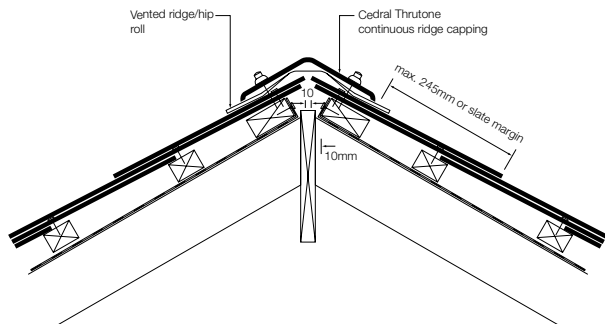

The Cedral continuous ventilated ridge and hip roll is manufactured for use with all Cedral's dry fix ridges. The ventilated ridge and hip roll provides 5000mm²/m ventilation to the roof apex.

Fixing

- 1 Underlay should be split along the apex of the roof and tacked to the back of the top slating battens ensuring a 5mm clear air gap is maintained.
- 2 Fix the top course slate batten to suit the gauge of the slate size being used and fix an additional ridge fix batten downslope to enable the 60mm x 6.3mm self-sealing wood screw fixings to penetrate the ridge unit 50mm from its bottom edge. (Certain constructions may require a longer screw fixing. In such cases, consult the Cedral Technical Support Department on +353 (0) 59 863 1316)
- 3 Head nail the top course slates to the top battens either side of the ridge apex, ensuring a 5mm clear gap is maintained between the top edges.

Ventilated ridge and hip roll

- 4 Unroll a 5 metre length of continuous ridge and hip roll (sold separately) centrally along the length of the ridge apex. (At gable ends the roll should overlap the gable end by approximately 50mm or in the case of a mortar bedded verge cut back 50mm from the gable.)
- 5 Remove the release paper covering the butyl strip on the underside of the corrugations on both sides of the roll and press the corrugations onto the top course slates either side of the ridge line without deforming or flattening the corrugations.

Important: Ensure the area of slates onto which the butyl strips will be adhering is thoroughly dry and dust free.

- 6 Repeat this process along the entire length of ridge, overlapping the roll ends by 100mm at each joint.
- 7 Position the first ridge at one end of the roof apex, above the ridge and hip roll, and drill and screw the end of the ridge to the ridge fix battens. Holes should be drilled 125mm from the effective ends, 50mm up i.e. ignoring the socket.
- 8 For exposed locations apply a 6mm dia. butyl strip across the socket, 50mm from the end.
- 9 Locate successive ridge units above the ridge and hip roll along the ridge, drill and screw to the ridge fix battens, ensuring a level ridge with joints bedded onto the butyl strip.

Close mitred hips

Close mitred hip constructions should not be used on roof pitches below 35°.



Close mitred hips

Fixing

- 1 Dress the underlay along each slope and cut at the hip rafter.
Dress additional underlay along the hip rafter, overlapping 300mm on each side.
- 2 Fix roofing battens to the hip rafter and align on each slope.
Insert lead soakers* in every course up the hip.

Mitred slates cut from double blank units must be fixed with three copper nails and two copper disc rivets. The third nail must be fixed into either:

- A: An additional batten parallel and central to the slating battens securely fixed to at least two rafters on either side of the hip.
- B: A continuous board either side of the hip, again securely fixed.
- C: A continuous batten either side.

* Please refer to SR82 and BS5534: for width of soakers.

Open metal valley

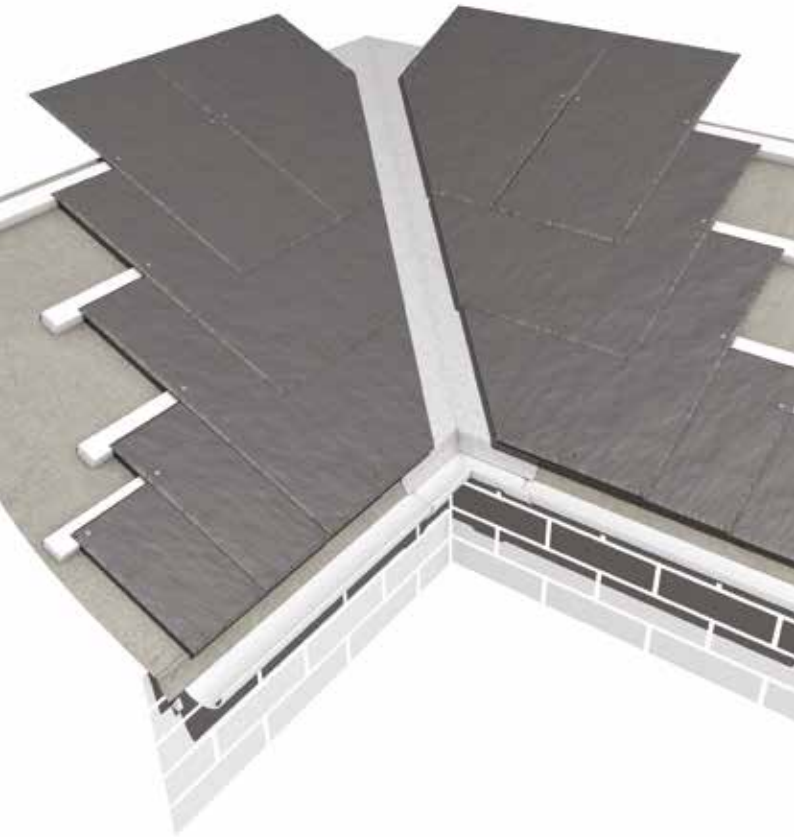

Open metal valley

Fixing

- 1 Fix support noggins to the inside of each rafter face at a level to receive individual lay boards between the rafters.
- 2 Nail valley boards to lay flush with the tops of the rafters, fix valley fillets ensuring sufficient valley width.
- 3 Drape the underlay and fix slating battens to bear 50mm on each valley board.
- 4 Lift the underlay and fix the lead gutter lining over the valley boards and dress on valley fillets. Form welts on the inside edges of the gutter lining, reposition the underlay over the welts edges of the valley and trim 40mm beyond the fillets.
- 5 Vertical infill noggins or raking battens may be required between the slating battens to accommodate the third slate nail.

Note: If trussed rafters are used, the manufacturer may not permit the notching of rafters. This can be overcome by fixing timber noggins to the insides of the rafter faces at a level to receive individual lay boards between the rafters.

- 6 Centre-nail slates, positioning rivets before fixing down. Ensure a 50mm overhang from the valley fillet and provide the required clear gutter to maintain an uninterrupted flow of water from the roof.

Note: Double width slates should be used in every course adjacent to the valley with additional nail fixings.

Abutments

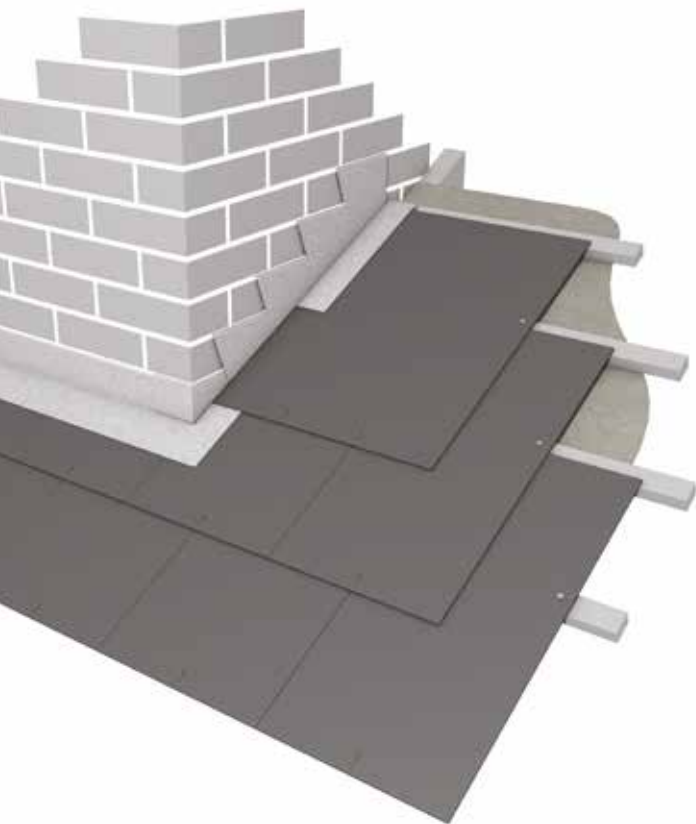

Abutments

Abutment with flashings

Where slates abut walls, chimney stacks, rooflights and dormer windows, etc., the jointing should be weathered by conventional lead soakers and flashings.

Soakers (Code 3 lead)

Lengths should equal the gauge + lap + 30mm, to allow the flashing to be formed over the batten. Minimum width: 175mm. Soakers should be turned up to provide a minimum 75mm upstand and cover flashing to suit.

Flashings (Code 4 or 5 lead)

Fix the flashings over the upstand of the soakers. The upper edge of the flashings should be turned into a groove in the walling, or the bed joint of the brickwork.

Where the slates abut brickwork, a stepped flashing to accommodate the heights of the horizontal brick courses should be used.

Secure the flashings in the wall with wedges and point with cement mortar, in accordance with the requirements of the Lead Sheet Association.

Apply a coating of 'Patination Oil' to all surfaces before the lead is fixed (see page 10).

Fibre cement in-line slate vents

Cedral's CVPI I In-line vent can be used with both fibre cement and natural slates and is available in 600 x 300 and 500 x 250mm.

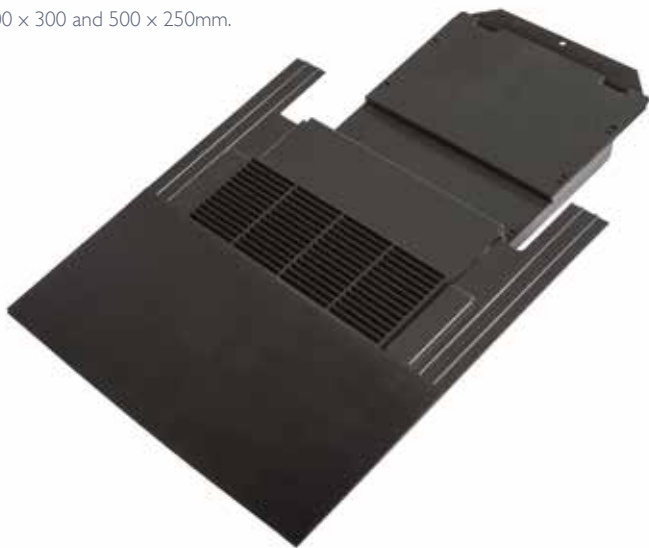

Fibre cement in-line slate vents

Fixing

- 1 Complete the slating in the normal manner to one course below the required position for the slate vent.
- 2 Temporarily fix slates directly below vent.

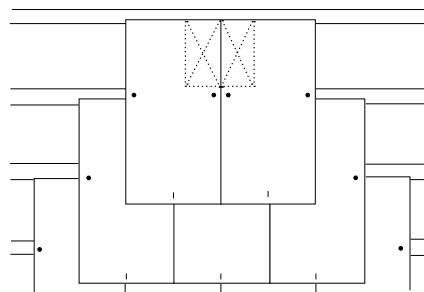

- 3 Mark the position of the vent on the slates. The vent should be as central between the rafters as practical.
- 4 Remove temporarily fixed slates.
- 5 Cut underlay in a "V" shape as shown. Fold back cut edges of underlay.

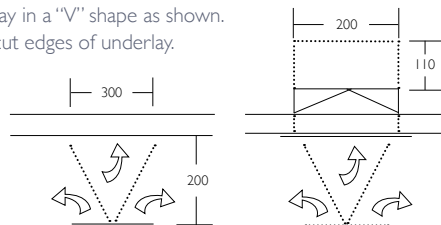

Fibre cement in-line slate vents

6 A Cedral felt weir (ref: CVFW) is available. This felt weir will give additional protection to the underlay cut. Neatly cut a 260mm long slot in underlay, at a distance of approx. 60mm above top of the slating batten. Slide the felt weir through this slot until the upstand of the felt weir is up to the bottom of the batten. Allow a minimum cover of 110mm between the felt weir and the underlay. Secure the felt weir by folding the top section of cut underlay over the batten and fix in place with a 20mm galvanised clout nail to the face or back edge of the batten.

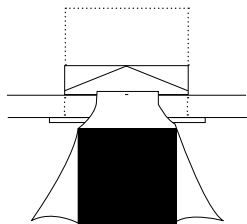

7 Cut out the top corner of the 2 slates in the course immediately below where the vent outlet is required to be positioned in the roof void. The dimensions of the piece of slate removed should be 190mm x 115mm, as shown. Re-hole the slates as necessary to ensure they can be fixed correctly to the slating battens.

Fibre cement in-line slate vents

8 Insert the ventilator into the roof void and secure with slating nails into the batten, ensuring that the vent sits closely onto the slates below.

The vent is designed for use with 25mm slating battens. Where a thicker batten is used then the back of the batten will need to be reduced to 25mm where it passes across the installed vent. Where the thickness of the slates on either side of the vent is greater than 8mm, then the same trimming of the batten may be necessary.

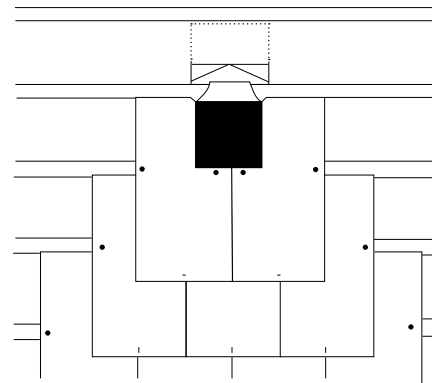

Fibre cement in-line slate vents

- 9 Fix the slates on either side of the vent and then cut and fit a piece of the slate to fit between the top of the grill and the finished line of the slating in the batten above (approx. 300mm). Cut a piece of the same slate 110mm in length to fit the bottom of the vent. Ensure that this piece of slate is dry and free from dust or loose material. Remove the paper covering the butyl strips and stick the slate in place. Ensure the top edge fits under the front edge of the grill and the bottom edge of the slate is flush with the vent slate.
- 10 If the degree of exposure of the site, or the location of the vent on the roof, gives cause for concern with regard to the security of the bottom edge of the vent, it may be further secured either by using a nail point slate hook or a copper disc rivet inserted through the hole provided. Additionally there is provision to secure the underside of the vent to the slating batten inside the roof void. This could be desirable if a particularly long or heavy flexible pipe is attached to the vent, which might cause it to deform.

Any water entering the vent will drain from the space between the bottom edge of the vent and the cut slate.

Contact Cedral's Technical Support Department for detailed information on ventilation principles and design requirements.

Fibre cement in-line slate vents

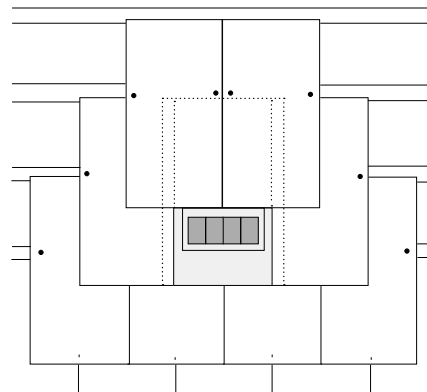

Specification:

Size: To suit 600 x 300mm slates & 500 x 250mm slates.

Capacity: 10,000mm² free air flow

Outlet: 110mm



CEDRAL | ACADEMY

Raising the standards of roofing

Cedral Academy for roofing installers

Back in 2015, we proudly launched the Tegral Academy as part of our initiative to raise the standards of roofing in Ireland. Still today it remains Ireland's only dedicated roofing training centre. Since then we have welcomed over 1,000 roofers into our factory and training centre in Co. Kildare.

And now, as Tegral slates have changed to Cedral slates, our academy has become the Cedral Academy.

We are still Ireland's only manufacturer of fibre cement slates and are proud Guaranteed Irish members, supporting local products and jobs. And still dedicated to raising the standards of roofing.

Topics include:

BC(A)R regulations

Common defects

Ventilation

and more...

To find out more visit cedral.ie

Support and back up

Technical Support

At Cedral, we pride ourselves on our technical expertise. Our Technical Support Department, which are staffed by a highly qualified team, have specialist knowledge not only of Cedral products, but also crucially, how those systems integrate with other roofing components and comply with building regulations, health and safety and environmental criteria.

For all technical queries, please contact us at:

Tel: +353 (0) 59 863 1316

Email: support.ireland@cedral.world

Customer Service & Sales

We have a team of highly experienced local advisors covering every corner of Ireland who are available to discuss your roofing requirements, as well as a dedicated internal customer service team, who are on hand to support.

Tel: +353 (0) 59 863 1316

Email: info.ireland@cedral.world

At Cedral, we are committed to providing outstanding customer care, supporting your project at every stage.

This document is protected by International copyright laws. Reproduction and distribution in whole or in part without prior written permission is strictly prohibited. Cedral is a registered trademark of Etex Ireland or an affiliate thereof. Any use without authorisation is prohibited and may violate trademark laws.

CEDRAL



The World of Roofs



more at cedral.ie

Tel: +353 (0) 59 863 1316 Email info.ireland@cedral.world
Etex Ireland Limited, Kilkenny Road, Athy, Co. Kildare, R14VN84

March 2021